



INSTRUCTIONS D'ASSEMBLAGE
ASSEMBLY INSTRUCTIONS

MONARCH
SPECIALTIES INC.

I 7754

CHAISE DE BUREAU -
NOIR SIMILI-CUIR / SUREELEVÉE

OFFICE CHAIR -
BLACK LEATHER-LOOK / STAND-UP DESK





POUR DE L'ASSISTANCE OU POUR COMMANDER
DES PIÈCES CONTACTEZ NOTRE DÉPARTEMENT
DE SERVICE À LA CLIENTÈLE.

FOR ASSISTANCE OR TO ORDER PARTS
CONTACT OUR CUSTOMER SERVICE DEPARTMENT

WWW.MONARCHSERVICE.COM

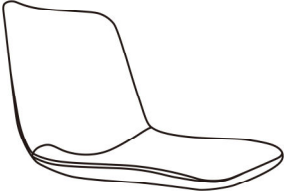
LISTE DES PIÈCES
PARTS LIST

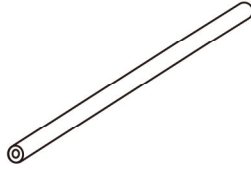
PIÈCE / PART #	IMAGE	DESCRIPTION	QTY / QTÉ
1		CHAIR DOSSIER	1
2		LEFT CHAIR LEG PATTE DE CHAISE GAUCHE	1
3		RIGHT CHAIR LEG PATTE DE CHAISE DROITE	1
4		SUPPORT BAR BARRE DE SOUTIEN	2

LISTE DES PIÈCES DE MONTAGE
HARDWARE LIST

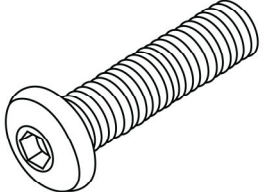
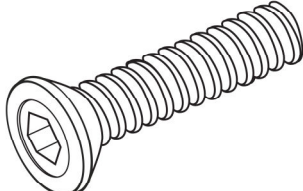
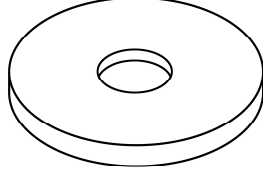
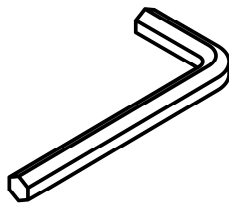
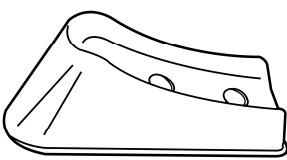
PIÈCE / PART #	IMAGE	DESCRIPTION	QTY / QTÉ
A		ASSEMBLING BOLT - Ø 1/4" X 1 1/4" BOULON D'ASSEMBLAGE - Ø 1/4" X 1 1/4"	6
B		ASSEMBLING BOLT - Ø 1/4" X 1 1/4" BOULON D'ASSEMBLAGE - Ø 1/4" X 1 1/4"	4
C		METAL WASHER - Ø 1/4" X 1/2" RONDELLE DE MÉTAL - Ø 1/4" X 1/2"	6
D		HEX KEY CLÉ HEXAGONALE	1
E		FLOOR PROTECTOR - 1" X 2 1/4" PROTECTEUR DE PLANCHER - 1" X 2 1/4"	4

LISTE DES PIÈCES DE MONTAGE
HARDWARE LIST

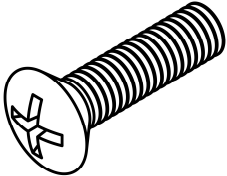
PIÈCE / PART #	IMAGE	DESCRIPTION	QTY / QTÉ
F		ASSEMBLING BOLT - Ø 1/8" X 5/8" BOULON D'ASSEMBLAGE - Ø 1/8" X 5/8"	8



OUTIL DE VÉRIFICATION DE DIMENSIONS DES PIÈCES
HARDWARE DIMENSIONS VERIFICATION TOOL



ÉTAPE / STEP 1

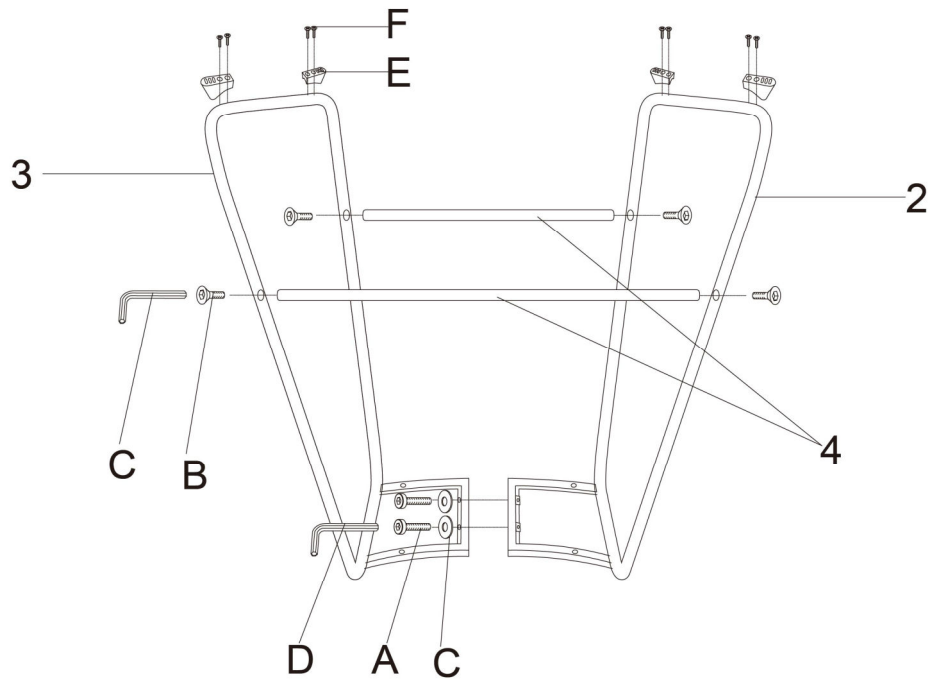

ÉTAPE / STEP 2

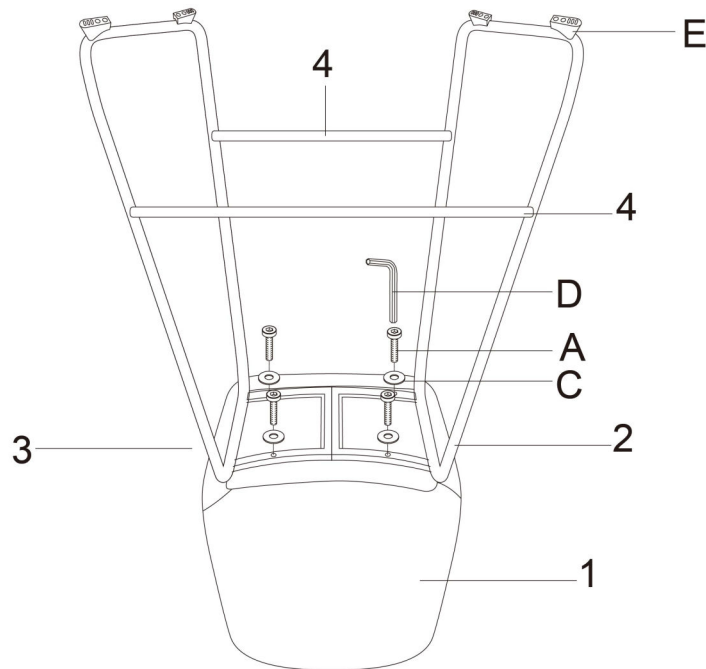

ÉTAPE / STEP 3

